

7 01 0188 02100
Zahnstange, Form 4,
gegenlaufend,
Zungenlänge 22mm,
Zungenbreite 18mm

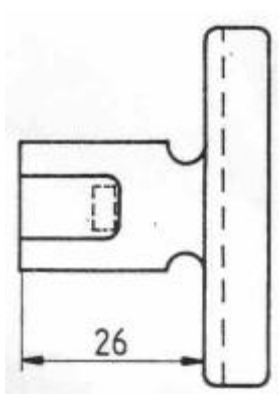

7 01 0188 05100
Zahnstange, Form 4,
gegenlaufend,
Zungenlänge 26 mm,
Zungenbreite 18mm

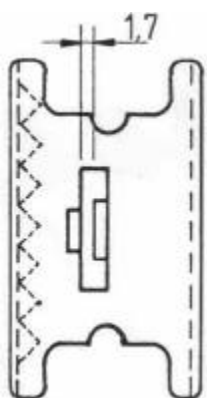
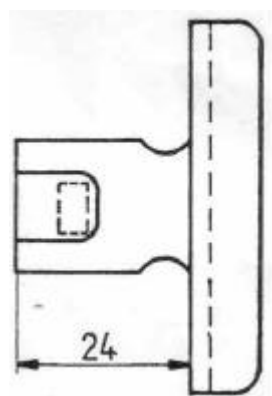
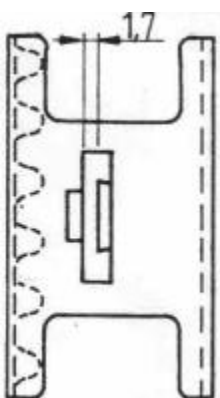

7 01 0135 02100
Zahnstange, Form 3 m.
dickem Boden 1,7mm,
gegenl., Zungenl. 24mm,
Zungenbr. 18mm

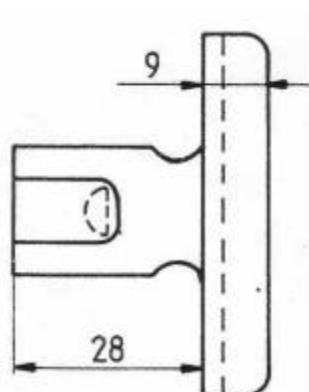
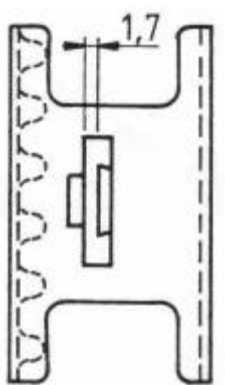

7 01 0135 05100
Zahnstange, Form 3,
gegenlaufend, mit
dickem Boden (1,7
mm), lange Zunge 18mm

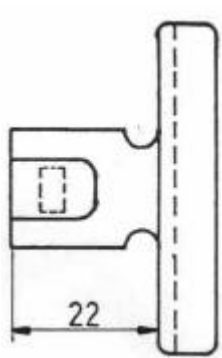
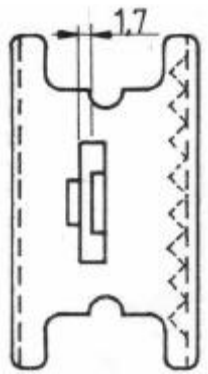

7 01 0188 02000
Zahnstange, Form4,
gleichlaufend,
Zungenbreite 18mm

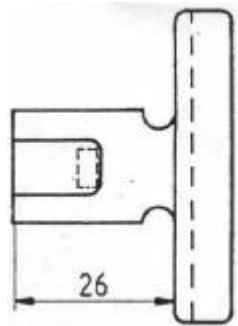
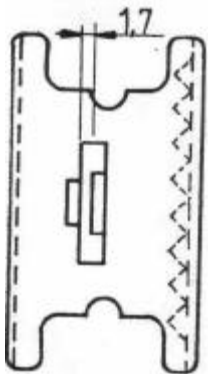

7 01 0188 05000
Zahnstange, Form4,
gleichlaufend,
Zungenbreite 18mm

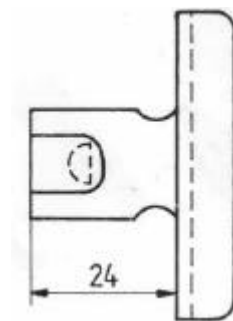
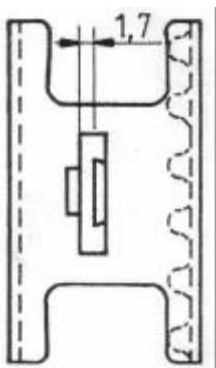

7 01 0135 02000
Zahnstange, Form3,
mit dickem Boden,
gleichlaufend,
Zungenlänge 24 mm

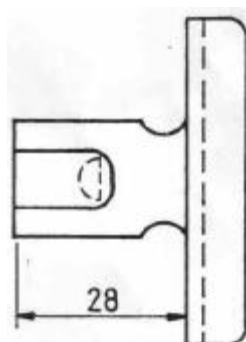
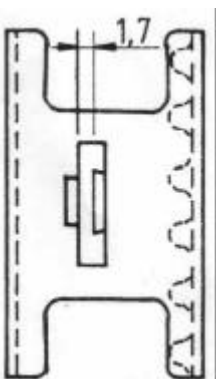

7 01 0135 05000
Zahnstange, Form3,
mit dickem Boden,
gleichlaufend,
Zungenlänge 28 mm



Zahnstangen Form3 mit Schwalbenschwanzzunge

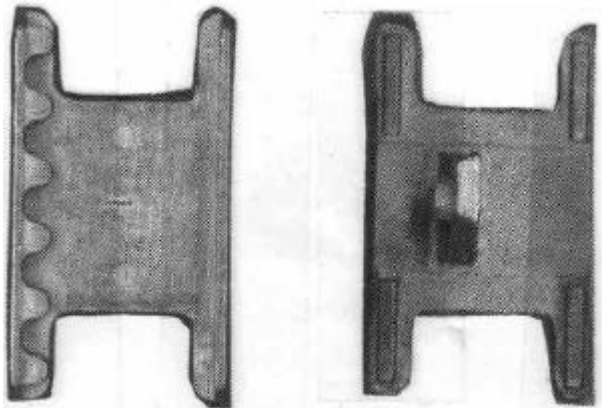

7 01 0264 02000
gleichlaufend

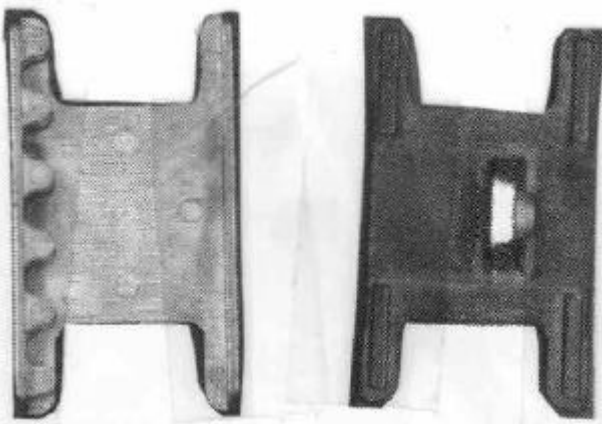

7 01 0264 02100
gegenlaufend

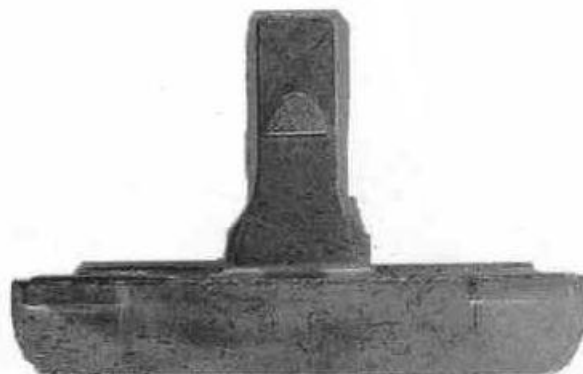



Zahnstange Form 4 mit Schwalbenschwanzzunge

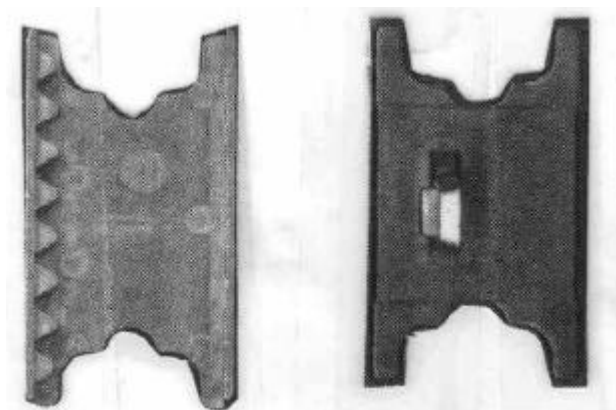

7 01 0765 02000
gleichlaufend

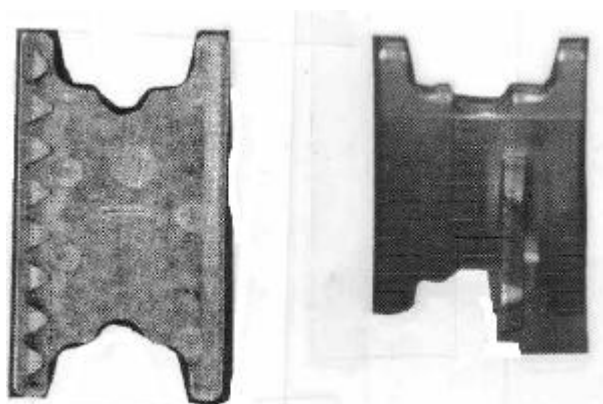

7 01 0765 02100
gegenlaufend



Zahnstangen für Getriebe

Form 4

7 01 0764 02000

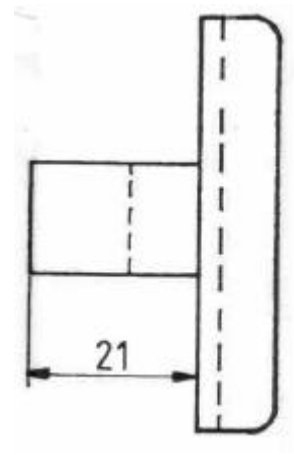
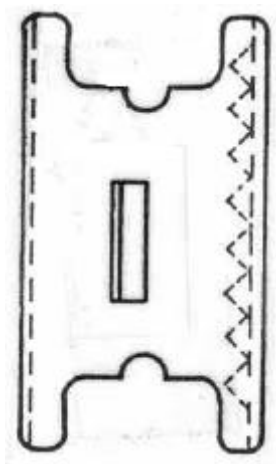

Form 3

7 01 0076 02000

